

# INSTALLATION MANUAL



## ZERO POINT SYSTEM (ZPS)

Installation of K10, K20, K40 clamping module

Hydraulic and pneumatic



## ZERO POINT SYSTEM (ZPS)

### CONTENTS

<b>GENERAL REMARKS</b>	<b>3</b>
<b>0. INTRODUCTION</b>	<b>3</b>
0.1 Operating personnel.....	4
0.2 Trained personnel.....	4
0.3 Individual protective equipment.....	4
0.4 General Safety Instructions .....	5
0.5 Behavior in case of emergency .....	5
0.6 Restrictions on usage.....	5
0.7 Type plates.....	6
<b>1. TRANSPORT</b>	<b>6</b>
<b>2. DESCRIPTION OF THE SYSTEM</b>	<b>7</b>
2.1 Structure of the Zero Point System (ZPS).....	8
2.2 Circuit diagram of the Zero Point System (ZPS) .....	9
2.3 Operation of the Zero Point System (ZPS) .....	10
<b>3. INSTALLATION</b>	<b>11</b>
3.1 General .....	11
3.2 Installation in a mounting hole.....	12
3.3 Removal from a mounting hole .....	14
<b>4. CLAMPING STUD</b>	<b>15</b>
4.1 Design.....	15
4.2 Installation instructions.....	15
4.3 Tolerances and clamping stud arrangement.....	15
<b>5. PERFORMANCE AND RESTRICTIONS ON USE</b>	<b>17</b>
5.1 Pull-in and locking force .....	17
5.2 Holding force .....	17
5.3 Safety precautions.....	17
<b>6. MAINTENANCE</b>	<b>17</b>
6.1 Introduction.....	17
6.2 Safety standards during maintenance .....	18
6.3 Daily maintenance .....	18
6.4 Monthly maintenance .....	18
6.5 Annual maintenance, but at the latest after 150,000 cycles .....	18
<b>7. POSSIBLE PROBLEMS AND REMEDYING THEM</b>	<b>19</b>
<b>8. DEACTIVATION AND DISPOSAL</b>	<b>20</b>
8.1 Deactivate.....	<b>Error! Bookmark not defined.</b>
8.2 Placing into storage .....	20
8.3 Disposal.....	20

# INSTALLATION MANUAL

## ZERO POINT SYSTEM (ZPS)

### GENERAL REMARKS

The present installation manual will assist you in becoming familiar with your new product. For that reason we recommend that you read the documentation and carefully follow all instructions.

For additional information we request that you contact Jergens Workholding Solutions Group at 877-426.2504.

### THIS MANUAL

Please consider this installation manual an important component of the delivered system. It should be well taken care of during the entire time the system is in use.

A copy of the present installation manual must be made available to the installation, operating and maintenance personnel.

Please ensure that all additional documents delivered are integrated into this manual. If your system is transferred to a third party, we request that you also pass on this manual.

### STORAGE OF THE MANUAL

Always handle this manual with care.

It is not permissible to tear out pages or modify it.

Please store these documents protected from heat and humidity.

Jergens Inc., reserves the right to replace parts of the instructions contained herein at any time in the course of product improvement or if construction or commercial changes so demand, without immediately providing a new edition.

As the author of these instructions, Jergens Inc., prohibits the reproduction in whole or even in part of these instructions, as well as any provision to third parties without written permission. Any modification of the product requires permission of the manufacturer.

## 0. Introduction



### **CAUTION:**

**The original configuration of this system may not be modified under any conditions.**

The use of this system for purposes other than those which the manufacturer intended can cause harm to the system or to the operator himself. Advance permission from the manufacturer must be obtained before machining materials other than those described in these instructions.

### **Symbols used**



Machining processes that represent a risk, or can cause injuries or harm to health if they are not properly performed.



Machining processes that may only be performed by qualified specialist personnel. The possibility of residual risks cannot be ruled out.

## ZERO POINT SYSTEM (ZPS)

### 1. Operating personnel

Certain operations may be performed exclusively by qualified or trained personnel. The following standard features are used to describe the qualification level:

Qualified personnel have sufficient technical knowledge or work experience to be able to recognize and prevent possible dangers (engineers and technicians).

Trained personnel are appropriately instructed and/or monitored by qualified persons to be able to recognize the dangers and prevent them (personnel assigned to operation or maintenance). They must have the following qualifications:

1. Trained and authorized to operate the product safely and supply it with operating pressure or interrupt the supply, and to mark it in accordance with the standard safety regulations.
2. Trained in the correct procedure for maintenance and use of safety equipment in accordance with the standard safety regulations.

Before commissioning the equipment, the customer is obligated to make sure:

1. Personnel has obtained, read and understood the installation manual;
2. Personnel follow the instructions provided.

### 2. Trained personnel

**MACHINE OPERATORS:** Personnel based on appropriate instructions from the owner of the Zero Point System (ZPS), are assigned and authorized to operate it and connected devices. In addition, a complete knowledge and unlimited understanding of the contents of the present handbook.

### 3. Individual protective equipment



Personnel must wear the appropriate protective clothing that is required for the use of the working machine on which the Zero Point System (ZPS) is installed.

Safety shoes are required, whereas the necessity of wearing hearing protectors, safety hats and safety goggles must be judged by the operating company.

The wearing of loose clothing that could become caught in the movable machine components is not permitted.

---

# INSTALLATION MANUAL

## ZERO POINT SYSTEM (ZPS)

### 3.1 General Safety Instructions

---



The following regulations and recommendations correspond to the applicable legal regulations and are largely based on the observance of such safety regulations.

JERGENS INC. is not liable for any harm to persons or property that can be traced back to disregarding the applicable safety regulations and/or the instructions contained in the present handbook. The respective most recent version of the installation manual is applicable.

All affected operators are therefore urged to follow and apply the instructions below and to strictly comply with the applicable accident protection regulations in the respective country where the system is installed and used.

All ordinary and extraordinary maintenance steps must be undertaken with the pressure supply off.

Before connecting the pressure, the operating pressure must be in accordance with the maximum allowable operating pressure.

Transportation, installation, operation and ordinary or extraordinary maintenance of the Zero Point System may be undertaken only by personnel meeting the requirements in sections 0.1 and 0.2.

---

### 3.2 In case of emergency

---



It is recommended that the operating and maintenance instructions of the machine on which the Zero Point System is installed be applied in emergencies.

In particular, measures must be taken so that no danger to persons or property can arise in case of a defect.

In case of fire, take the designated extinguishing measures and ensure that operating pressure is no longer present.

---

### 3.3 Restrictions on usage

---



The Zero Point system (ZPS) may be used solely for the uses specified in the installation manual, and only in combination with the components recommended and approved by JERGENS INC.

---

## ZERO POINT SYSTEM (ZPS)

**Usage of the Zero Point System (ZPS):** The ZPS is a spring-actuated single-acting clamping element that clamps a clamping plate or a workpiece, pressure-free and self-locked with the Jergens clamping stud. It is intended for installation on or in machines or systems, and may be used only within the scope of its technical data. The maximum loads and operating pressures specified by the manufacturer must not be exceeded. All other types of use must be approved by the manufacturer.

The ZPS is suitable only to a limited extent in certain explosive environments. Further information regarding this application is contained in separate installation instructions.

### 3.4 Type plates

A label or the type plate of the manufacturer is affixed to the Zero Point System.

---



#### **CAUTION!**

**Labels must not be removed under any conditions, even if the equipment is to be re-sold.**

**Should the label be damaged or become detached, please contact JERGENS INC. to obtain a copy.**

**In all communications with JERGENS INC. please always mention the model stamped on the label. Disregarding these provisions releases JERGENS INC. from any liability for damage or accidents caused thereby. In this case, the operating company is solely liable to the authorities.**

---

### 4. Transport

Every Zero Point System (ZPS) is carefully tested before shipping. Upon receipt of the product, please check the integrity of the packaging and contents (subject to other instructions on the part of Jergens Inc.), to assure that the equipment was not damaged during transport and that the delivery corresponds to the specification of the order. Please report any defects or damage immediately to JERGENS INC. and the shipper who is liable for the transport damage.

---



#### **CAUTION!**

**Any defects or damage must be protested within 10 days of the receipt of the product.**

---

## ZERO POINT SYSTEM (ZPS)

### 5. Description of the system

#### Technical data sheet – Hydraulic version:

	Unit	K10	K20	K40
Pull-in and locking force in the system up to	[kN] / (lbs)	10 / (2,250)	20 / (4,500)	40 / (9,000)
Holding force	[kN] / (lbs)	25 / (5,620)	55 / (12,350)	105 / (23,600)
Maintenance after ....clamping cycles		150,000	150,000	150,000
<b>Min. operating pressure</b>	<b>[bar] / (psi)</b>	<b>50 / (725)</b>	<b>50 / (725)</b>	<b>50 / (725)</b>
<b>Max. operating pressure</b>	<b>[bar] / (psi)</b>	<b>60 / (870)</b>	<b>60 / (870)</b>	<b>60 / (870)</b>
Opening volume	[cm <sup>3</sup> ] / (in <sup>3</sup> )	3,0 / (.19)	10,0 / (.61)	27,0 / (1.65)
Pre-positioning	[mm] / (in)	6,5 / (.256)	12 / (.472)	12 / (.472)
Repeatability	[mm] / (in)	<0.005 / (< 0.0002)	<0.005 / (< 0.0002)	<0.005 / (< 0.0002)
Max. permissible lateral forces	[kN] / (lbs)	10 / (2,250)	20 / (4,500)	20 / (4,500)
Max. operating temperature	[°C] / (°F)	80 / 176	80 / 176	80 / 176



#### **CAUTION!**

It must be assured, by means of a pressure regulation valve for example, that the maximum operating pressure is not exceeded. The safety factor is not contained in the specification of the operating pressure. It must be further taken into account individually, depending on the application case.

#### Technical data sheet – Pneumatic version:

	Unit	K10	K20	K40
Pull-in and locking force in the system up to	[kN] / (lbs)	8,5 / (1,900)	17 / (3,800)	30 / (6,700)
Holding force	[kN] / (lbs)	25 / (5,620)	55 / (12,350)	105 / (23,600)
Maintenance after ....clamping cycles		150,000	150,000	150,000
<b>Min. opening operating pressure</b>	<b>[bar] / (psi)</b>	<b>8 / (116)</b>	<b>8 / (116)</b>	<b>8 / (116)</b>
<b>Max. opening operating pressure</b>	<b>[bar] / (psi)</b>	<b>12 / (175)</b>	<b>12 / (175)</b>	<b>12 / (175)</b>
<b>Min. operating pressure for retensioning</b>	<b>[bar] / (psi)</b>	<b>5 / (75)</b>	<b>5 / (75)</b>	<b>5 / (75)</b>
<b>Max. operating pressure for retensioning</b>	<b>[bar] / (psi)</b>	<b>6 / (90)</b>	<b>6 / (90)</b>	<b>6 / (90)</b>
Opening volume	[cm <sup>3</sup> ] / (in <sup>3</sup> )	3,0 / (.19)	10,0 / (.61)	27,0 / (1.65)
Pre-positioning	[mm] / (in)	6,5 / (.256)	12 / (.472)	12 / (.472)
Repeatability	[mm] / (in)	<0.005 / (< 0.0002)	<0.005 / (< 0.0002)	<0.005 / (< 0.0002)
Max. permissible lateral forces	[kN] / (lbs)	10 / (2,250)	20 / (4,500)	20 / (4,500)
Max. operating temperature	[°C] / (°F)	80 / 176	80 / 176	80 / 176

## ZERO POINT SYSTEM (ZPS)



### CAUTION!

A pressure regulation device must be used to assure that the maximum operating pressure is never exceeded. The safety factor is not incorporated in the specification of the operating pressure. It must be taken into account for each individual application.

### 5.1 Structure of the Zero Point System (ZPS)

#### Hydraulic version

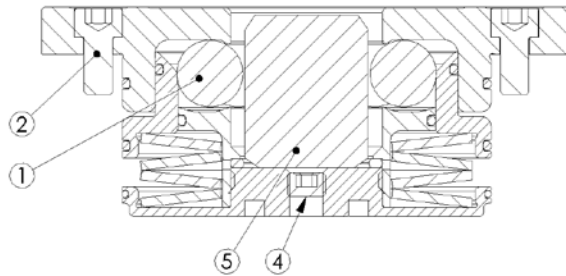

#### Pneumatic version

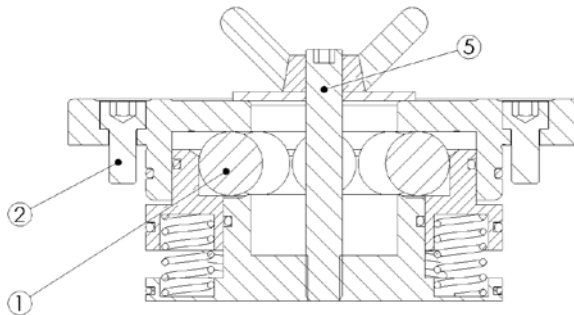

1. Ball
2. Cylinder screw
3. Threaded stud as forcing screw  
(not shown in the drawing)
4. Threaded stud
5. Assembly tools preinstalled



# INSTALLATION MANUAL

## ZERO POINT SYSTEM (ZPS)

### 5.2 Circuit diagram of the Zero Point System (ZPS)

Description of the required connections:

#### Hydraulic version

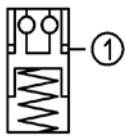

**Zero Point System without pneumatic blow out**

1 = Unclamp hydraulically

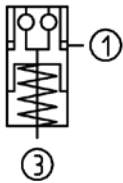

**Zero Point System with pneumatic blow out**

1 = Unclamp hydraulically  
3 = Blow-out pneumatically

#### Pneumatic version

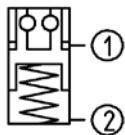

**Zero Point System without pneumatic blow out**

1 = Unclamp pneumatically  
2 = Clamp pneumatically

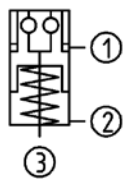

**Zero Point System with pneumatic blow out**

1 = Unclamp pneumatically  
2 = Clamp pneumatically  
3 = Blow-out pneumatically

# INSTALLATION MANUAL

## ZERO POINT SYSTEM (ZPS)

### 5.3 Operation of the Zero Point System (ZPS)

**Vent:** After installation of the hydraulic ZPS modules in a base, the entire system must be vented.

#### Hydraulic version

##### **Unclamping procedure:**

Pressurize ZPS.

The ZPS will release the clamping stud, enabling it to be moved in and out of the system. The ZPS will remain unclamped as long as pressure is applied to the Open connection.

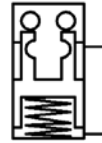

##### **Clamping procedure:**

Depressurize ZPS.

The ZPS locks positively and is mechanically clamped by spring force. The ZPS will remain clamped as long as no pressure is applied to the Open connection. Pressure line can be decoupled after the clamping process – the ZPS will remain positively locked.



#### Pneumatic version

##### **Unclamping procedure:**

Pressurize ZPS.

Clamping connection must be pressure-free.

The ZPS will release the clamping stud, enabling it to be moved in and out of the ZPS. The ZPS will remain unclamped as long as pressure is applied to the Open connection.

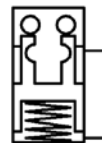

##### **Clamping procedure:**

Depressurize ZPS.

Pressurize clamping connection briefly, then remove pressure.

The ZPS is positively locked and mechanically clamped by spring force. The ZPS will remain clamped as long as no pressure is applied to the Open connection. Pressure



## ZERO POINT SYSTEM (ZPS)

line can be decoupled after the clamping process – the ZPS will remain positively locked..

### Integrated blow-out procedure

(only for ZPS with blow-out):

The air escapes from the ZPS in the center and serves to clean the interior space and the seat. During operation, there is danger of eye injury, since shavings can arise from the automatic blow out.



---

#### **CAUTION!**

Wear safety goggles

---

### Manual blow-out:

The interior of the ZPS can be blown out with an ordinary commercial compressed air blow gun or suctioned out with a vacuum device.

During operation, there is danger of eye injury, since shavings can arise from the blow out.



---

#### **CAUTION!**

Wear safety goggles

---

## 6. Installation

### 6.1 General

Safety is only guaranteed if the Zero Point System (ZPS) is properly connected according to applicable safety regulations.



---

#### **CAUTION!**

Only qualified personnel may connect the ZPS to the pressure supply.

**Follow the installation manual for the pressure intensifier in this regard.**

---

If several ZPS are installed side by side, care must be taken that the height variation of the contact surfaces remains within 0.02 mm ( 0.0008”).

The spacing tolerances between the ZPS should not exceed +/- 0.01 mm (+/- 0.0004”).

The change pallet to be clamped with the integrated clamping studs must always rest against the contact surface of the ZPS in the clamped state.

# INSTALLATION MANUAL

## ZERO POINT SYSTEM (ZPS)

### 6.2 Installation in a mounting hole



**Do not remove assembly tool for the pneumatic and hydraulic version**



**Remove rubber ring**

**Important:**

**Neatly deburr mounting holes, clean hole and contact surface, check elements for greased state**



**Tilt-free introduction**

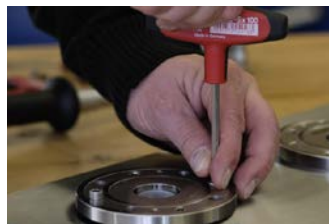

**Uniform insertion of 4 opposing cylinder screws, up to flat contact.**

The threaded studs → must not be driven in too far; otherwise the cover cannot make lay flat.



**CAUTION: The spring is pre-tensioned at installation.**

## ZERO POINT SYSTEM (ZPS)

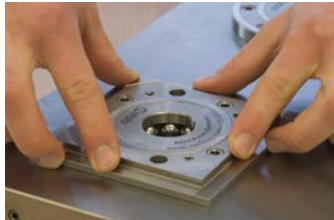

**Additional instruction for the square ZPS:**

**Precise alignment of the square faces, insertion of the cylinder pin into the alignment hole (see installation sketch) and covering of the outside surfaces with liquid adhesive for fixation.**



**Uniform** tightening of the cylinder screws with the following torque:

**K10: (M5)5 Nm / (4 ft. lbs)**

**K20: (M6)8 Nm / (6 ft. lbs)**

**K40: (M8)21 Nm / (16 ft. lbs)**

**K40: (M8)21 Nm / (16 ft. lbs)**

**After installation, the bearings must be able to move freely in the track**



**Remove assembly tool**

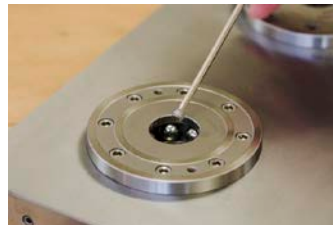

**Screw threaded stud ↓ into ZPS base and glue in with soluble adhesive for stainless steel.**

**Caution!** Do not lift the base of the ZPS via the threaded stud. For this purpose, it can be screwed back again by one-half turn after contact with the bottom of the mounting hole.

# INSTALLATION MANUAL

## ZERO POINT SYSTEM (ZPS)

### 6.3 Removal from a mounting hole



---

**CAUTION:**

The system must be completely depressurized before dismantling.

---



Remove threaded stud



Uniformly loosen cylinder screws



---

**CAUTION** Spring is pre-tensioned in the installed state.

---

**Note:** Springs must not have any pre-tension.



Insert assembly tool



Screw in threaded stud in order to be able to press the clamping system down

## ZERO POINT SYSTEM (ZPS)



**Uniform and tilt-free removal of the clamping system**

**Note on assembly tool:** Screw long cylinder screw with large washer that covers the central hole for the clamping stud into the base of the ZPS. In this way, the ZPS can be held together before removal so that it can be taken out as a unit.

The supply holes for the pressure medium must be free during removal, as otherwise a vacuum could arise in the mounting hole.

### 7. Clamping stud

#### 7.1 Design

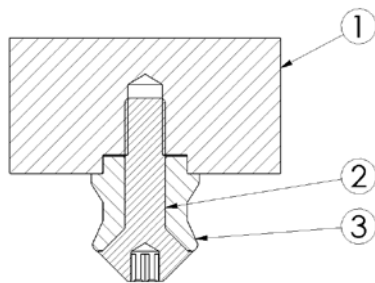

1. Pallet to be changed
2. Engagement screw
3. Clamping stud

#### 7.2 Installation instructions

The clamping stud with the engagement screw is to be inserted into the provided hole of the pallet. Please observe the arrangement of the various stud shapes and the arrangement of the ZPS timing stud.

Tighten engagement screw with the **torque wrench** and defined torque.

**K10: (M8)34 Nm (25 ft. lbs)**

**K20: (M12)120 Nm (90 ft. lbs)**

**K40: (M16)180 Nm (135 ft. lbs)**

#### 7.3 Tolerances and clamping stud arrangement

The clamping studs have the following designs:

## ZERO POINT SYSTEM (ZPS)



Zero-point stud (1)  
- for full centring



Timing stud (2)  
- for centring the remaining free axis



Clearance stud (3)  
- exclusively for holding and clamping function

**Bottom view of a change pallet with representation of the arrangement of the various clamping studs (drawing simplified):**

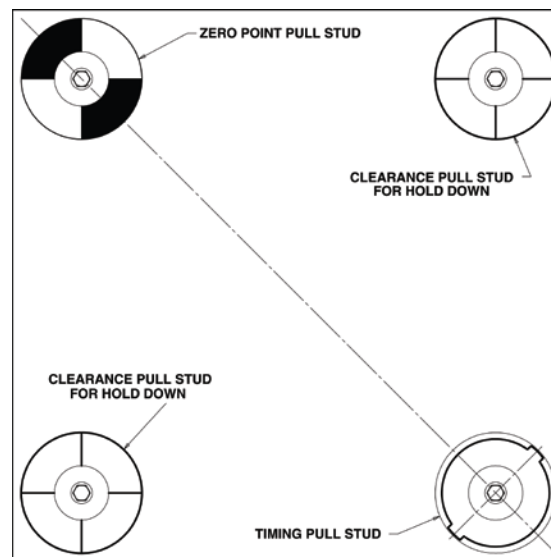

**Note:** The raised portions of the diameter on the timing stud must be oriented at 90 deg. to the centerline between the zero point stud and the timing stud itself.

**Distance tolerance:**

A = Zero-point to timing stud: +/- 0.01 mm (+/- 0.0004")



## ZERO POINT SYSTEM (ZPS)

B = Zero-point/timing stud to clearance stud: +/- 0'.03 mm (+/- 0.0012")

### 8. PERFORMANCE AND RESTRICTIONS ON USE

#### 8.1 Pull-in and locking force

The pull-in and locking force describes the force with which the stud is pulled in and clamped with positive locking in the clamping module.

#### 8.2 Holding force

The holding force specifies the maximum permissible axial pull force of the engagement screw. A safety value suitable for the application must be additionally be taken into consideration.

Elevated tensile forces can cause a material-induced elastic deformation of the components.

#### 8.3 Safety precautions

**Safety catch:** An additional mechanical safety catch must be attached for vertical and horizontally suspended clamping. For this usage, the user must consider a risk analysis of the forces occurring and then carry out an accident risk assessment in order to take appropriate protective measures. People are not permitted to be present in the danger zone.

**Rotary applications:** For rotary clamping, piston location sensing and contact monitoring are mandatory. For rotary usage, the user must consider a risk analysis of the shearing, centrifugal and imbalance forces occurring and then carry out an accident risk assessment in order to take appropriate protective measures. People are not permitted to be present in the danger zone.

### 9. MAINTENANCE

#### 9.1 Introduction

Appropriate maintenance is important for a long service life of the system and its components and additionally guarantees the required operating safety over the long term.

## ZERO POINT SYSTEM (ZPS)

### 9.2 Safety standards during maintenance

---



#### **CAUTION!**

All maintenance steps must be undertaken by qualified personnel (see chapter 0.1).

Here are the most important points for the performance of maintenance measures:

Maintenance and repair measures must be undertaken with a depressurized system. The entire operating, maintenance and cleaning personnel must also strictly observe the applicable accident prevention regulations in the country where the machine is installed.

The ZPS is constantly under high spring pressure. Due to pre-tensioning of the spring stack, serious, even life-threatening injuries can result if maintenance is improper.

Always wear safety shoes and all other required individual safety gear as well as clothing that covers the body as completely as possible.

Do not wear any rings, watches, necklaces, bracelets or loose clothing.

To guarantee flawless functionality, use only original replacement parts.

Do not use abrasive or corrosive materials for cleaning the ZPS as they may impair the legibility of the markings or type plates.

---

### 9.3 Daily maintenance

Check the interior of the ZPS for contamination. It can be cleaned with an ordinary commercial compressed air gun (wear safety goggles) or with a chip vacuum.

### 9.4 Monthly maintenance

- Visual inspection of the condition of the ZPS
- Check the mounting screws and engagement screws for firm seating
- Remove deposits on the module surface
- Check for integrity and functionality of the system
- Check the pressure hoses or tubing
- Check the oil level, change oil if needed

### 9.5 Annual maintenance, but at the latest after 150,000 cycles

Dismantling of the ZPS and replacement of the O-rings and the spring stack.

Exchanging both elements is recommended as preventive repair. Preventive repair should be done at shorter intervals in case of very frequent clamping processes. The procedure for this should be coordinated with JERGENS INC.

## ZERO POINT SYSTEM (ZPS)

### 10. POSSIBLE PROBLEMS AND REMEDYING THEM

The information contained in this section supports the user in the identification of malfunctions that can occur during operation of the system.

<b>Malfunction</b>	<b>Cause</b>	<b>Remedy</b>
The ZPS no longer opens completely	- Opening pressure is too low - Oil level in the pressure generator is too low	- Check operating pressure at the pressure generator and add oil if needed
Visible oil in the interior of the ZPS	- Seals defective	- Dismantle ZPS, replace seals

# INSTALLATION MANUAL

## ZERO POINT SYSTEM (ZPS)

### 11. DEACTIVATION AND DISPOSAL

#### 11.1 Deactivate

If the equipment is no longer going to be used, disconnect the system from the pressure supply and remove it from the production machine on which it is installed.

#### 11.2 Placing into storage

The following points should be considered:

- Clean and grease the surface of the Zero Point System.
- Keep the system in a dry environment between +10° (50°F) - 55°C (131°F).

#### 11.3 Disposal

- Under EU directives or local regulations, the operating company is responsible for scrapping and disposing of the various materials of which the system is composed.
- In the scrapping of the system, observe the relevant safety regulations to prevent the dangers occurring during the dismantling of industrial machines. Pay particular attention to :
- Dismantling the equipment from the system on which it is installed.
- Scrapping the equipment.
- Sorting the various materials of which the equipment is composed.
- Some fundamental rules for environmental protection must be observed in the scrapping and disposal of the equipment. Please carefully separate and dispose of the materials and observe the applicable national and local regulations for the disposal of solid, toxic and harmful industrial waste.
- Seals, hoses, plastic parts and other non-metallic components must be separately disposed of.
- Electrical components such as switches, transformers, sockets, etc. can be dismantled for reuse, as long as they are in good condition and have been tested.

INSTALLATION MANUAL  
ZERO POINT SYSTEM (ZPS)



[www.jergensinc.com](http://www.jergensinc.com)  
15700 South Waterloo Road  
Cleveland, OH 44110  
877-426-2504  
workholding@jergensinc.com