



Jergens®

OPEN UP YOUR FIVE-AXIS MACHINING POSSIBILITIES

FIXTURE-PRO® SELF-CENTERING VISE LINE



JERGENS WORKHOLDING SOLUTIONS

FIXTURE-PRO® SELF-CENTERING VISE LINE

Jergens latest family of self-centering vises has been engineered to be the ideal solution for low profile five-axis workholding. Available in both 130mm and 75mm widths, they can accommodate a wide array of workpiece sizes. The quick change jaws incorporate a pull down feature to actively minimize jaw lift. Multiple jaw styles make this vise system configurable for most workholding needs, from first operation to finish work.

Clamping Force:

- 75mm vises: 3,500 lbs @ 50 ft*lbs
- 130mm vises: 3,600 lbs @50 ft*lbs
- Leadscrew features rolled trapezoidal threads for superior strength and durability
- Low friction surface treatment of critical components improves performance and reduces wear
- Adjustable centerline for easy re-centering

VERSATILE MOUNTING OPTIONS

Vises easily mount to a number of modular fixture platforms, adding to Jergens industry leading selection of quick change fixturing.

QUICK LOCATING SYSTEM (QLS)

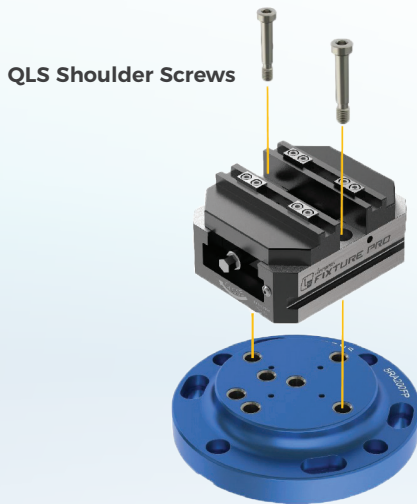

Fixture-Pro Base Element with QLS Grid on 50mm Spacing

*75mm vises require adapter plate (5VA13075) for QLS Mounting

PALLET MOUNTING

- Quick-Loc™
- Drop-n-Lock™

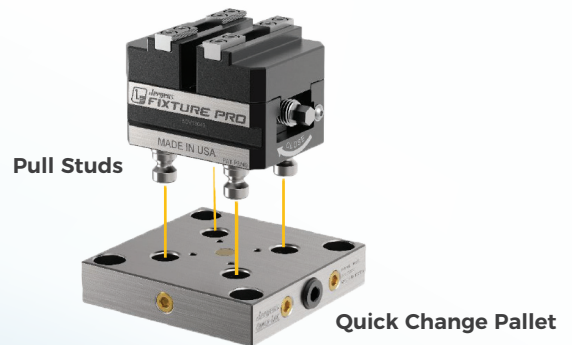

PALLET COMPATIBILITY

Pallet System	Pull Stud Part No.	75mm Vise	130mm Vise
52mm Quick-loc	QL-200800	♦	♦
96mm Quick-loc	QL-200805		♦
60mm Drop-n-Lock	5QP020		♦



75MM SELF-CENTERING VISE

Vises can be ordered with alternate jaw types by adding the one of the following suffixes to a base part number:

- **A** for aluminum soft jaws
- **H** for hardened step jaws
- **S** for steel soft jaws
- **IN** for insert jaws

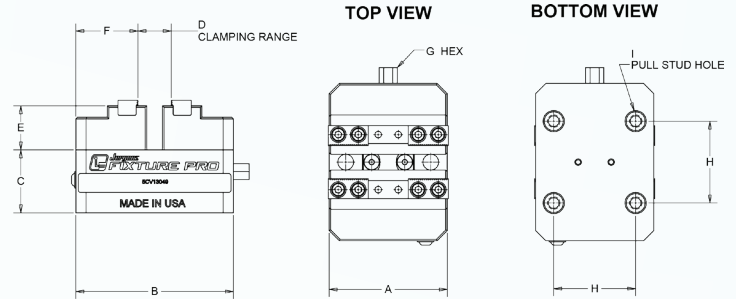

Part Number	A (mm)	B (mm)	C (mm)	D (mm)	E (mm)	F (mm)	G (mm)	H (mm)	I (part no.)	Pull Studs Included	Weight (kg)
5CV13049-IN	75	100	40	12-85	28	39.5	10	52	QL-200800	No	3.1
5CV13050-IN	75	100	40	12-85	28	39.5	10	52	QL-200800	Yes	3.3

130MM SELF-CENTERING VISE

Vises can be ordered with alternate jaw types by adding the one of the following suffixes to a base part number:

- **A** for aluminum soft jaws
- **H** for hardened step jaws
- **S** for steel soft jaws
- **IN** for insert jaws

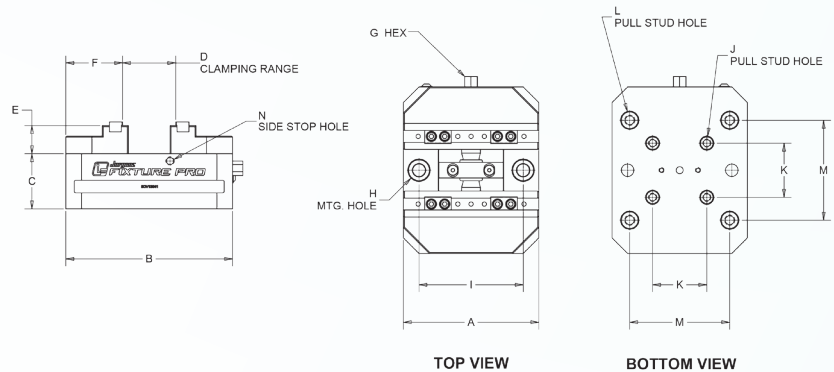

Part Number	A (mm)	B (mm)	C (mm)	D (mm)	E (mm)	F (mm)	G (mm)	H	I (mm)	J (part no.)	K (mm)	L (part no.)	M (mm)	Pull Studs Included	N	Weight (kg)
5CV13041-IN	130	160	53	12-150	27	54	12	12mm QLS	100	QL-200800	52	QL-200805	96	No	M8 X 1.25	7.4
5CV13042-IN	130	160	53	12-150	27	54	12	12mm QLS	100	QL-200800	52	QL-200805	96	Yes (QL-200805)	M8 X 1.25	7.7
5CV13043-IN	130	160	53	12-150	27	54	12	12mm QLS	100	5QP020	60	-	-	No	M8 X 1.25	7.4
5CV13044-IN	130	160	53	12-150	27	54	12	12mm QLS	100	5QP020	60	-	-	Yes	M8 X 1.25	7.7
5CV13045-IN	130	250	53	12-240	27	54	12	12mm QLS	100	QL-200800	52	QL-200805	96	No	M8 X 1.25	10.2

JAW OPTIONS

- Quick change jaws, no tools required
- Reversible Jaws
- Pull-down design minimizes jaw lift

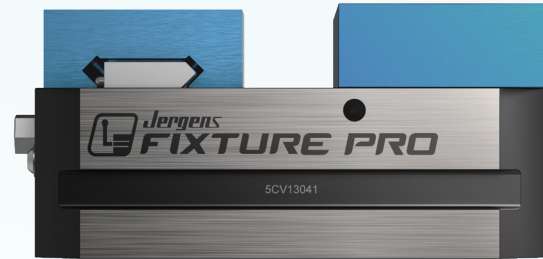

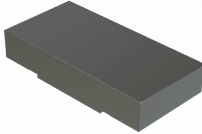
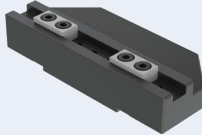
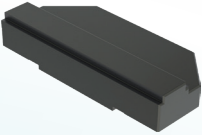
Type	Description	Suitable for	Part Number
	Steel Soft Jaw	75mm	5CV13049-SSJ
		130mm	5CV13041-SSJ
	Insert Jaw	75mm	5CV13049-INSJ
		130mm	5CV13041-INSJ
	Hardened Step Jaw	75mm	5CV13049-HSJ
		130mm	5CV13041-HSJ
	Aluminum Soft Jaw	75mm	5CV13049-ASJ
		130mm	5CV13041-ASJ



WORLD HEADQUARTERS

15700 S. Waterloo Road
Cleveland, OH 44110-3898

☎ 877-486-1454

🌐 jergensinc.com

✉ info@jergensinc.com

WORKHOLDING SOLUTIONS

☎ 877-426-2504

🌐 jergensinc.com/workholding

✉ workholding@jergensinc.com



ALSO AVAILABLE:

JERGENS WORKHOLDING SOLUTIONS CATALOG

Request a copy or download at www.jergensinc.com

